



CALL NO. 302

CONTRACT ID. 192383

SHELBY COUNTY

FED/STATE PROJECT NUMBER FD04 106 1779 000-006

DESCRIPTION BENSON PIKE (KY 1779)

WORK TYPE ASPHALT RESURFACING

PRIMARY COMPLETION DATE 7/31/2020

LETTING DATE: October 25,2019

Sealed Bids will be received electronically through the Bid Express bidding service until 10:00 AM EASTERN DAYLIGHT TIME October 25,2019. Bids will be publicly announced at 10:00 AM EASTERN DAYLIGHT TIME.

NO PLANS ASSOCIATED WITH THIS PROJECT.

REQUIRED BID PROPOSAL GUARANTY: Not less than 5% of the total bid.

TABLE OF CONTENTS

PART I	SCOPE OF WORK
	<ul style="list-style-type: none">• PROJECT(S), COMPLETION DATE(S), & LIQUIDATED DAMAGES• CONTRACT NOTES• STATE CONTRACT NOTES• SURFACING AREAS• ASPHALT MIXTURE• DGA BASE FOR SHOULDERS• INCIDENTAL SURFACING• FUEL AND ASPHALT PAY ADJUSTMENT• COMPACTION OPTION B• SPECIAL NOTE(S) APPLICABLE TO PROJECT• DOUBLE ASPHALT SEAL COAT• EDGE KEY (BY TON)• ASPHALT MILLING AND TEXTURING• TYPICAL SECTION DIMENSIONS• TRAFFIC CONTROL PLAN 2 LANE-CLOSED• DURABLE PAVEMENT EDGE DETAILS• SKETCH MAP(S)• SUMMARY SHEET(S)• TYPICAL SECTION(S)• BRIDGE DETAIL FOR PAVING PROJECT
PART II	SPECIFICATIONS AND STANDARD DRAWINGS
	<ul style="list-style-type: none">• SPECIFICATIONS REFERENCE• SUPPLEMENTAL SPECIFICATION• 2016 STANDARD DRAWINGS THAT APPLY
PART III	EMPLOYMENT, WAGE AND RECORD REQUIREMENTS
	<ul style="list-style-type: none">• LABOR AND WAGE REQUIREMENTS• EXECUTIVE BRANCH CODE OF ETHICS• KENTUCKY EQUAL EMPLOYMENT OPPORTUNITY ACT OF 1978 LOCALITY / STATE• PROJECT WAGE RATES / STATE FUNDED
PART IV	INSURANCE
PART V	BID ITEMS

PART I
SCOPE OF WORK

ADMINISTRATIVE DISTRICT - 05

CONTRACT ID - 192383

FD04 106 1779 000-006

COUNTY - SHELBY

PCN - MP10617791901

FD04 106 1779 000-006

BENSON PIKE (KY 1779) (MP 0.000) BEGIN AT KY 1871 EXTENDING EAST TO KY 395 (MP 6.133), A DISTANCE OF 06.13 MILES.ASPHALT RESURFACING SYP NO. 05-20044.00.

GEOGRAPHIC COORDINATES LATITUDE 38:13:26.00 LONGITUDE 85:07:15.00

COMPLETION DATE(S):

COMPLETED BY 07/31/2020

APPLIES TO ENTIRE CONTRACT

CONTRACT NOTES

PROPOSAL ADDENDA

All addenda to this proposal must be applied when calculating bid and certified in the bid packet submitted to the Kentucky Department of Highways. Failure to use the correct and most recent addenda may result in the bid being rejected.

BID SUBMITTAL

Bidder must use the Department's electronic bidding software. The Bidder must download the bid file located on the Bid Express website (www.bidx.com) to prepare a bid packet for submission to the Department. The bidder must submit electronically using Bid Express.

JOINT VENTURE BIDDING

Joint venture bidding is permissible. All companies in the joint venture must be prequalified in one of the work types in the Qualifications for Bidders for the project. The bidders must get a vendor ID for the joint venture from the Division of Construction Procurement and register the joint venture as a bidder on the project. Also, the joint venture must obtain a digital ID from Bid Express to submit a bid. A joint bid bond of 5% may be submitted for both companies or each company may submit a separate bond of 5%.

UNDERGROUND FACILITY DAMAGE PROTECTION

The contractor shall make every effort to protect underground facilities from damage as prescribed in the Underground Facility Damage Protection Act of 1994, Kentucky Revised Statute KRS 367.4901 to 367.4917. It is the contractor's responsibility to determine and take steps necessary to be in compliance with federal and state damage prevention directives. When prescribed in said directives, the contractor shall submit Excavation Locate Requests to the Kentucky Contact Center (KY811) via web ticket entry. The submission of this request does not relieve the contractor from the responsibility of contacting non-member facility owners, whom shall be contacted through their individual Protection Notification Center. Non-compliance with these directives can result in the enforcement of penalties.

REGISTRATION WITH THE SECRETARY OF STATE BY A FOREIGN ENTITY

Pursuant to KRS 176.085(1)(b), an agency, department, office, or political subdivision of the Commonwealth of Kentucky shall not award a state contract to a person that is a foreign entity required by [KRS 14A.9-010](#) to obtain a certificate of authority to transact business in the Commonwealth ("certificate") from the Secretary of State under [KRS 14A.9-030](#) unless the person produces the certificate within fourteen (14) days of the bid or proposal opening. If the foreign entity is not required to obtain a certificate as provided in [KRS 14A.9-010](#), the foreign entity should identify the applicable exception. Foreign entity is defined within [KRS 14A.1-070](#).

For all foreign entities required to obtain a certificate of authority to transact business in the Commonwealth, if a copy of the certificate is not received by the contracting agency within the time frame identified above, the foreign entity's solicitation response shall be deemed non-responsive or the awarded contract shall be cancelled.

Businesses can register with the Secretary of State at <https://secure.kentucky.gov/sos/ftbr/welcome.aspx>.

SPECIAL NOTE FOR PROJECT QUESTIONS DURING ADVERTISEMENT

Questions about projects during the advertisement should be submitted in writing to the Division of Construction Procurement. This may be done by fax (502) 564-7299 or email to kytc.projectquestions@ky.gov. The Department will attempt to answer all submitted questions. The Department reserves the right not to answer if the question is not pertinent or does not aid in clarifying the project intent.

The deadline for posting answers will be 3:00 pm Eastern Daylight Time, the day preceding the Letting. Questions may be submitted until this deadline with the understanding that the later a question is submitted, the less likely an answer will be able to be provided.

The questions and answers will be posted for each Letting under the heading "Questions & Answers" on the Construction Procurement website (www.transportation.ky.gov/contract). The answers provided shall be considered part of this Special Note and, in case of a discrepancy, will govern over all other bidding documents.

HARDWOOD REMOVAL RESTRICTIONS

The US Department of Agriculture has imposed a quarantine in Kentucky and several surrounding states, to prevent the spread of an invasive insect, the emerald ash borer. Hardwood cut in conjunction with the project may not be removed from the state. Chipping or burning on site is the preferred method of disposal.

INSTRUCTIONS FOR EXCESS MATERIAL SITES AND BORROW SITES

Identification of excess material sites and borrow sites shall be the responsibility of the Contractor. The Contractor shall be responsible for compliance with all applicable state and federal laws and may wish to consult with the US Fish and Wildlife Service to seek protection under Section 10 of the Endangered Species Act for these activities.

ACCESS TO RECORDS

The contractor, as defined in KRS 45A.030 (9) agrees that the contracting agency, the Finance and Administration Cabinet, the Auditor of Public Accounts, and the Legislative Research Commission, or their duly authorized representatives, shall have access to any books, documents, papers, records, or other evidence, which are directly pertinent to this contract for the purpose of financial audit or program review. Records and other prequalification information confidentially

disclosed as part of the bid process shall not be deemed as directly pertinent to the contract and shall be exempt from disclosure as provided in KRS 61.878(1)(c). The contractor also recognizes that any books, documents, papers, records, or other evidence, received during a financial audit or program review shall be subject to the Kentucky Open Records Act, KRS 61.870 to 61.884.

In the event of a dispute between the contractor and the contracting agency, Attorney General, or the Auditor of Public Accounts over documents that are eligible for production and review, the Finance and Administration Cabinet shall review the dispute and issue a determination, in accordance with Secretary's Order 11-004.

April 30, 2018

SPECIAL NOTE FOR RECIPROCAL PREFERENCE

RECIPROCAL PREFERENCE TO BE GIVEN BY PUBLIC AGENCIES TO RESIDENT BIDDERS

By reference, KRS 45A.490 to 45A.494 are incorporated herein and in compliance regarding the bidders residency. Bidders who want to claim resident bidder status should complete the Affidavit for Claiming Resident Bidder Status along with their bid in the electronic bidding software. Submittal of the Affidavit should be done along the bid in Bid Express.

April 30, 2018

SURFACING AREAS

The Department estimates the mainline surfacing width to be varied 18 to 22 feet.

The Department estimates the total mainline area to be surfaced to be 77,503 square yards.

The Department estimates the shoulder width to be 1 foot on each side.

The Department estimates the total shoulder area to be surfaced to be 7,196 square yards.

ASPHALT MIXTURE

Unless otherwise noted, the Department estimates the rate of application for all asphalt mixtures to be 110 lbs/sy per inch of depth.

DGA BASE FOR SHOULDERS

Unless otherwise noted, the Department estimates the rate of application for DGA Base for Shoulders to be 115 lbs/sy per inch of depth. The Department will not measure necessary grading and/or shaping of existing shoulders prior to placing of DGA Base, but shall be incidental to the Contract unit price per ton for DGA Base.

Accept payment at the Contract unit price per ton as full compensation for all labor, materials, equipment, and incidentals for grading and/or shaping of existing shoulders and furnishing, placing, and compacting the DGA Base.

INCIDENTAL SURFACING

The Department has included in the quantities of asphalt mixtures established in the proposal estimated quantities required for resurfacing or surfacing mailbox turnouts, farm field entrances, residential and commercial entrances, curve widening, ramp gores and tapers, and road and street approaches, as applicable. Pave these areas to the limits as shown on Standard Drawing RPM-110-06 or as directed by the Engineer. In the event signal detectors are present in the intersecting streets or roads, pave the crossroads to the right of way limit or back of the signal detector, whichever is the farthest back of the mainline. Surface or resurface these areas as directed by the Engineer. The Department will not measure placing and compacting for separate payment but shall be incidental to the Contract unit price for the asphalt mixtures.

FUEL AND ASPHALT PAY ADJUSTMENT

The Department has included the Contract items Asphalt Adjustment and Fuel Adjustment for possible future payments at an established Contract unit price of \$1.00. The Department will calculate actual adjustment quantities after work is completed. If existing Contract amount is insufficient to pay all items on the contract with the adjustments, the Department will establish additional monies with a change order.

OPTION B

Be advised that the Department will control and accept compaction of asphalt mixtures furnished on this project under OPTION B in accordance with Sections 402 and 403.

SPECIAL NOTE FOR FULL DEPTH RECLAMATION WITH CEMENT

1. GENERAL

1.1. Description. Full-depth reclamation (FDR) with cement, shall consist of pulverizing and mixing existing asphalt pavement and base course material with portland cement, soil, and water to produce a dense, hard, cement treated base. It shall be proportioned, mixed, placed, compacted, and cured in accordance with this specification, and shall conform to the lines and grades shown in the plan.

2. MATERIALS

2.1. Recycled Asphalt Pavement (RAP) and Base Material. Shall consist of the existing asphalt pavement, existing base course material and/or subgrade material. The base course and subgrade material shall not contain roots, topsoil, or any material deleterious to its reaction with cement. The particle distribution of the processed material shall be such that 100% passes a 3-inch sieve, at least 95% passes a 2-inch sieve, at least 55% passes a No. 4 sieve, and maximum 20% passing the 200 sieve.

2.1.1. Mix Design. Remove samples of RAP and base material to the specified depth and perform appropriate testing to establish mix design. Submit mix design to the Engineer for approval one week before the planned start of work. Approval of the mix design by the Engineer is solely for monitoring quality control and in no way releases the Contractor from his responsibilities.

2.1.2. Mix Design Development. Mix Design Development - Samples must be obtained inclusive of the depth to be recycled. Sampled materials must be properly processed and prepared to closely simulate field conditions (use auger cuttings taken from the surface to 2-3 inches below the treatment depth). A Qualified Technical Representative will analyze the samples and provide the following information as part of the mix design to the Engineer:

- Location of core samples.
- Thickness and description of existing pavement and aggregate layers to be reclaimed.
- A selected matrix of soils testing standards (performed on mixed sample, except T208.)
 - Moisture Content AASHTO T265 - Mechanical and Hydrometer
 - Particle Size Analysis of Soils AASHTO T88
 - Liquid Limit AASHTO T89
 - Plastic Limit AASHTO T90
 - Moisture Density AASHTO T99
 - Unconfined Compression AASHTO T208 - To be performed on subgrade soil only if more than 20% of the underlying subgrade is to be included in the portland cement stabilized layer.

2.2. Cement. Shall comply with Section 801 of the KYTC Standard Specifications for Road and Bridge Construction, current edition.

2.3. Water. Shall be free from substances deleterious to the curing of the cement-treated material.

3. EQUIPMENT

3.1. Description. FDR may be constructed with any machine or combination of machines that will produce a satisfactory product meeting the requirements for depth of pulverization, cement and water application, mixing, compacting, finishing, and curing as provided in this specification.

3.2. Mixing Methods. Mixing shall be accomplished in place, using single-shaft or multiple-shaft mixers. Agricultural disks or motor graders are not acceptable mixing equipment.

3.3. Cement Proportioning. Spreading of the cement shall be done with a spreader truck designed to spread dry particulate such as cement to insure a uniform distribution. Spreaders or distributors used shall be able to demonstrate a consistent and accurate application rate, as well as dust control during application. The mechanical cement spreader shall be capable of dispensing a measured quantity of cement +/- 3 lbs per square yard in advance of the pulverizer just prior to each pass of the stabilizing operation. The pulverizer shall abut or slightly overlap (3") previous pass to ensure a continuous homogeneous mass of granular material and cement. Cement spreader does not have to abut or overlap previous pass as long as the calculated quantity of cement is dispersed in front of the pulverizer.

3.4. Application of Water. Water may be applied through the mixer or with water trucks equipped with pressure-spray bars. If using the spray bar system, road base shall be pre-wet to obtain optimum moisture content prior to the dispensing of cement. Do not apply water directly to the roadway before or after cement placement without first pulverizing the roadbed.

3.5. Compaction. Compact the FDR base uniformly to a minimum of 98% of maximum dry density in accordance with ASTM D558 or AASHTO T134 based on a moving average of five consecutive tests with no individual test below 96%. Establish a compaction pattern that will achieve the required density without over compaction.

4. CONSTRUCTION REQUIREMENTS

4.1. General

4.1.1. Preparation. Methods, equipment, tools, and any machinery to be used during construction shall be approved by the Engineer prior to the start of the project. Prior to the actual reclaiming of the roadway, drop inlets or catch basins that might be affected shall be sufficiently barricaded to prevent reclaimed subbase material, silt or runoff from plugging the drainage system.

Sufficient surface drainage must be provided for each stage of construction so that ponding does not occur on the reclaimed sub-base course prior to the placement of bituminous concrete.

Reclamation shall be accomplished by means of a self-propelled, traveling rotary reclaimer or equivalent machine capable of cutting through existing bituminous concrete pavement to depths of up to 15 inches with one pass. The machine shall be equipped with an adjustable grading blade leaving its path generally smooth for initial compaction. Equipment such as road planers or cold milling machines designed to mill or shred the existing bituminous concrete, rather than crush or fracture it, shall not be allowed.

Existing bituminous concrete pavement and any underlying granular material must be pulverized and mixed so as to form a homogenous mass of reclaimed sub-base material which will bond together when compacted.

In areas where the vertical or horizontal geometry of the proposed roadway is different than that of the existing, the roadway shall be reclaimed in-place and the reclaimed material sub-base placed in windrows or stockpiled while any filling or excavation is performed. When the proposed sub-grade elevation is achieved, the reclaimed sub-base material will be placed back onto the roadway in lifts no greater than five (5) inches in depth before being compacted.

Reshaping using the reclaimed sub-base material should be minimized in order to insure that the roadway has a uniform thickness of reclaimed sub-base material throughout. Unless otherwise specified, when reshaping of the roadway is required, it should be performed utilizing additional sub-base or processed aggregate base.

The reclaimed sub-base material shall be compacted prior to the placement of any additional granular material used (sub-base or processed aggregate base). Subsequent to the compaction of the reclaimed sub-base material, any reshaped material or additional material placed on the roadway should not exceed five (5) inches in depth before being compacted.

A motor grader shall be used for shaping, fine grading, and finishing the surface of the reclaimed material or any other granular materials placed to form the surface prior to paving.

Any surface irregularities which develop during or after the above described work shall be corrected until it is brought to a firm and uniform surface satisfactory to the Engineer.

4.1.2. Mixing and Placing. FDR processing shall not commence when the soil aggregate or sub-grade is frozen, or when the air temperature is below 40°F (4°C). Moisture in the base course material at the time of cement application shall not exceed the quantity that will permit a uniform and intimate mixture of the pulverized asphalt, base material and cement during mixing operations, and shall be within +/-2% of the optimum moisture content for the processed material at start of compaction.

The operation of cement application, mixing, spreading, compacting, and finishing shall be

continuous and completed within 2 hours from the start of mixing. Any processed material that has not been compacted and finished shall not be left undisturbed for longer than 30 minutes.

4.1.3. Scarifying. Before cement is applied, initial pulverization or scarification may be required to the full depth of mixing. Scarification or pre-pulverization is a requirement for the following conditions:

- When the processed material is more than 3% above or below optimum moisture content. When the material is below optimum moisture content, water shall be added. The pre-pulverized material shall be sealed and properly drained at the end of the day or if rain is expected.
- For slurry application of cement, initial scarification shall be done to provide a method to uniformly distribute the slurry over the processed material without excessive runoff or ponding

4.2. Application of Cement. The specified quantity of cement shall be applied uniformly in a manner that minimizes dust and is satisfactory to the engineer. If cement is applied as a slurry, the time from first contact of cement with water to application on the soil shall not exceed 60 minutes. The time from cement placement on the soil to start of mixing shall not exceed 30 minutes.

4.3. Mixing. Mixing shall begin as soon as possible after the cement has been spread and shall continue until a uniform mixture is produced. The mixed material shall meet the following gradation conditions:

4.3.1. The final mixture (bituminous surface, granular base, and sub-grade soil) shall be pulverized such that 100% passes the 3-inch sieve, at least 95% passes the 2-in. sieve, and at least 55% passes the No. 4 sieve. Additional material can be added to the top or from the sub-grade to improve the mixture gradation, as long as this material was included in the mixture design.

4.3.2. The final pulverization test shall be made at the conclusion of mixing operations. Mixing shall be continued until the product is uniform in color, meets gradation requirements, and is at the required moisture content throughout. The entire operation of cement spreading, water application, and mixing shall result in a uniform pulverized asphalt, soil, cement, and water mixture for the full design depth and width.

4.4. Compaction. The processed material shall be uniformly compacted to a minimum of 98% of maximum density based on a moving average of five consecutive tests with no individual test below 95%. Field density of compacted material can be determined according to the KYTC standard specifications. Optimum moisture and maximum density shall be determined prior to start of construction and also in the field during construction by a moisture-density test approved by the Engineer.

At the start of compaction, the moisture content shall be within +/-2% of the specified optimum moisture. No section shall be left undisturbed for longer than 30 minutes during compaction operations. All compaction operations shall be completed within 2 hours from

start of mixing.

4.5. Finishing. As compaction nears completion, the surface of the FDR material shall be shaped to the specified lines, grades, and cross sections. If necessary or as required by the engineer, the surface shall be lightly scarified or broom-dragged to remove imprints left by equipment or to prevent compaction planes. Compaction shall then be continued until uniform and adequate density is obtained.

During the finishing process the surface shall be kept moist by means of water spray devices that will not erode the surface. Compaction and finishing shall be done in such a manner as to produce a dense surface free of compaction planes, cracks, ridges, or loose material. All finishing operations shall be completed within 4 hours from start of mixing.

4.6. Curing. Finished portions of the FDR base that are traveled on by equipment used in constructing an adjoining section shall be protected in such a manner as to prevent equipment from marring or damaging completed work.

After completion of final finishing, the surface shall be cured according to section 208.03.06 of the standard specifications.

4.7. Traffic. Completed portions of FDR base can be opened immediately to low-speed local traffic and to construction equipment if a curing seal is used and provided the curing material is not impaired, and provided the FDR base is sufficiently stable to withstand marring or permanent deformation. The section can be opened up to all traffic after the FDR base has received a curing compound or subsequent surface and is sufficiently stable to withstand marring or permanent deformation. If continuous moist curing is employed in lieu of a curing compound or subsequent surfacing within 7 days, the FDR base can be opened to all traffic after the 7-day moist curing period, provided the FDR base has hardened sufficiently to prevent marring or permanent deformation.

4.8. Surfacing. In most cases, allow the FDR to cure for a minimum of two days (48 hours after completing finishing operations) before applying a surface course in order to determine if any isolated soft spots exist. If the Engineer deems the situation warrants faster construction, the surfacing can be placed any time after finishing, as long as the soil-cement is sufficiently stable to support the required construction equipment without marring or permanent distortion of the surface.

4.9. Maintenance. The contractor shall maintain the cement-treated material in good condition until all work is completed and accepted. Maintenance shall include immediate repairs of any defects that may occur. If it is necessary to replace any processed material, the replacement shall be for the full depth, with vertical cuts, using either cement-treated material or concrete. No skin patches will be permitted. Such maintenance shall be done by the contractor at his own expense.

5. INSPECTION AND TESTING

5.1. Description. The contractor shall make such inspections and tests as deemed necessary to ensure the conformance of the work to the contract documents. These inspections and tests may include, but shall not be limited to:

Recycling operations including recycling speed, yield monitoring, monitoring treatment depth, procedures for avoiding recycling and curing in inclement weather, methods to ensure that segregation is minimized, procedures for mix design modification, grading and compacting operations, and cement application procedure.

Density testing of the recycled material will be performed using the nuclear method.

Only those materials, machines, and methods meeting the requirements of the contract documents shall be used unless otherwise approved by the engineer.

All testing of processed material or its individual components, unless otherwise provided specifically in the contract documents, shall be in accordance with the latest applicable ASTM or AASHTO specifications in effect as of the date of advertisement for bids on the project.

6. MEASUREMENT AND PAYMENT

6.1. Measurement.

6.1.1. Full Depth Reclamation. This Department will measure the quantity in square yards of completed and accepted full depth reclamation. The Department will not measure corrective or reconstructed work for payment. The Department will not measure water for payment and will consider it incidental to this item of work.

6.1.2. Asphalt Curing Seal. The Department measure curing seal for payment according to section 208 of the standard specifications.

6.2. Payment. This Department will make payment for the completed and accepted quantities under the following:

<u>Code</u>	<u>Pay Item</u>	<u>Pay Unit</u>
24936EC	Full Depth Reclamation with Cement	Square Yard
02542	Cement	Ton
00358	Asphalt Curing Seal	Ton

SPECIAL NOTE FOR NON-TRACKING TACK COAT

1. DESCRIPTION AND USEAGE. This specification covers the requirements and practices for applying a non-tracking tack asphalt coating. Place this material on the existing pavement course, prior to placement of a new asphalt pavement layer. Use when expedited paving is necessary or when asphalt tracking would negatively impact the surrounding area. This material is not suitable for other uses. Ensure material can “break” within 15 minutes under conditions listed in 3.2.
2. MATERIALS, EQUIPMENT, AND PERSONNEL.

2.1 Non-Tracking Tack. Provide material conforming to Subsection 2.1.1.

2.1.1 Provide a tack conforming to the following material requirements:

Property	Specification	Test Procedure
Viscosity, SFS, 77 • F	20 – 100	AASHTO T 72
Sieve, %	0.3 max.	AASHTO T 59
Asphalt Residue ¹ , %	50 min.	AASHTO T 59
Oil Distillate, %	1.0 max.	AASHTO T 59
Residue Penetration, 77 • F	20 max.	AASHTO T 49
Original Dynamic Shear (G*/sin δ), 82 • C	1.0 min.	AASHTO T 315
Softening Point, • F	149 min.	AASHTO T 53
Solubility, %	97.5 min.	AASHTO T 44

¹ Bring sample to 212 •F over a 10-15 minute period. Maintain 212 •F for 15-20 minutes or until 30-40 mL of water has distilled. Continue distillation as specified in T59.

2.2. Equipment. Provide a distributor truck capable of heating, circulating, and spraying the tack between 170 •F and 180 •F. Do not exceed 180 •F. Circulate the material while heating. As required by the manufacturer, ensure the spray bar is equipped with #1 or #2 ¼” V-slot Etnyre nozzles. Other nozzles are not acceptable. Arrange the nozzles in the following patterns from left to right:

Nozzle number(s)	Activity	Orientation
1	On	Vertical
2	Off	-
3	On	Horizontal
4 & 5	Off	-
6	On	Horizontal
Continue 2 off and 1 on pattern through rest of spray bar system.		

Ensure the bar can be raised to between 14 and 18” from the roadway.

2.3 Personnel. Ensure the tack supplier has provided training to the contractor on the installation procedures for this product. Make a technical representative from the supplier available at the request of the Engineer.

3. CONSTRUCTION.

3.1 Surface Preparation. Prior to the application of the non-tracking tack, ensure the pavement surface is thoroughly dry and free from dust or any other debris that would inhibit adhesion. Clean the surface by scraping, sweeping, and the use of compressed air. Ensure this preparation process occurs shortly before application to prevent the return of debris pavement. If rain is expected within one hour after application, do not apply material. Apply material only when the surface is dry, and no precipitation is expected.

3.2 Non-tracking Tack Application. Ensure the roadway temperature is a minimum of 40 °F and rising during the application of the tack. This material is not suitable for use in colder temperatures. Prior to applying the tack, demonstrate competence in applying the tack according to this note to the satisfaction of the Engineer. Heat the tack in the distributor to between 170 – 180 °F. After initial heating to between 170 – 180 °F, the material may be sprayed between 165 °F and 180 °F. Do not apply outside this temperature range. Apply material at a rate of 0.50 pounds (0.06 gallons) per square yard. Ensure full coverage of the material on the pavement surface. Full coverage of this material is critical. If full coverage is not achieved, material application rate may be increased to ensure full coverage. Do not heat material more than twice in one day.

3.3 Non-tracking Tack Certification. Furnish the tacks certification to the Engineer stating the material conforms to all requirements herein prior to use.

3.4 Sampling and Testing. The Department will require a sample of non-tracking tack be taken from the distributor at a rate of one sample per 15,000 tons of mix. Take two 1 gallon samples of the heated material and forward the sample to the Division of Materials for testing within 7 days. Ensure the product temperature is between 170 and 180 °F at the time of sampling.

4. MEASUREMENT. The Department will measure the quantity of non-tracking tack in tons. The Department will not measure for payment any extra materials, labor, methods, equipment, or construction techniques used to satisfy the requirements of this note. The Department will not measure for payment any trial applications of non-tracking tack, the cleaning of the pavement surface, or furnishing and placing the adhesive. The Department will consider all such items incidental to the non-tracking tack.

5. PAYMENT. The Department will pay for the non-tracking tack at the Contract unit bid price and apply an adjustment for each manufacturer's lot of material based on the degree of compliance as defined in the following schedule. When a sample fails on two or more tests, the Department may add the deductions, but the total deduction will not exceed 100 percent.

Non-Tracking Tack Price Adjustment Schedule						
Test	Specification	100% Pay	90% Pay	80% Pay	50% Pay	0% Pay
Viscosity, SFS, 77 • F	20 – 100	19 - 102	17 - 18	15 - 16	14	≤13
			103 - 105	106 - 107	108 - 109	≥ 110
Sieve, %	0.30 max.	• 0.40	0.41 - 0.50	0.51 - 0.60	0.61 - 0.70	≥ 0.71
Asphalt Residue, %	50 min.	• 49.0	48.5 – 48.9	48.0 – 48.4	47.5-47.9	≤ 47.4
Oil Distillate, %	1.0 max.	• 1.0	1.1-1.5	1.6 - 1.7	1.8-1.9	>2.0
Residue Penetration, 77 ° F	20 max.	• 21	22 - 23	24 - 25	26 - 27	≥ 28
Original Dynamic Shear (G*/sin δ), 82 • C	1.0 min.	• 0.95	0.92 – 0.94	0.90 – 0.91	0.85 - 0.89	≤ 0.84
Softening Point, ° F	149 min.	• 145	142 - 144	140 - 141	138 - 139	≤ 137
Solubility, %	97.5 min.	≥ 97.0	96.8 – 96.9	96.6 – 96.7	96.4 – 96.5	≤ 96.3

<u>Code</u>	<u>Pay Item</u>	<u>Pay Unit</u>
24970EC	Asphalt Material for Tack Non-Tracking	Ton

April 30, 2018

SPECIAL NOTE FOR DOUBLE ASPHALT SEAL COAT

Use RS-2 or RS-2C asphalt material that is compatible with the seal aggregate. Apply the first course of asphalt seal coat at the rate of 3.2 lbs/sy of asphalt and 30 lbs/sy of size #78 seal coat aggregate. Apply the second course at 2.8 lbs/sy of asphalt and 20 lbs/sy of size #9M seal coat aggregate. The Engineer may adjust the rate of application as conditions warrant. Use caution in applying liquid asphalt material to avoid over spray getting on curbs, gutter, barrier walls, bridges, guardrail, and other roadway appurtenances.

The Department will not measure any surface preparation required prior to applying the asphalt seal coat, but shall be incidental to “Asphalt Material for Asphalt Seal Coat”.

1-3215 Double Asphalt Seal Coat
01/02/2012

SPECIAL NOTE FOR EDGE KEY

Construct Edge Keys at the beginning of project, end of project, at railroad crossings, and at ramps, as applicable. Unless specified in the Contract or directed by the Engineer, do not construct edge keys at intersecting streets, roads, alleys, or entrances. Cut out the existing asphalt surface to the required depth and width shown on the drawing and heel the new surface into the existing surface. The Department will make payment for this work at the Contract unit price per ton for Asphalt Pavement Milling and Texturing, which shall be full compensation for all labor, materials, equipment, and incidentals for removal and disposal of the existing asphalt surface required to construct the edge key.

EDGE KEY



Thickness = 3.5 Inches

L = 350 LF

L= Length of Edge Key

1-3309 Edge key by Ton
01/02//2012

**SPECIAL NOTE FOR
ASPHALT MILLING AND TEXTURING**

Begin paving operations within **48 hours** of commencement of the milling operation. Continue paving operations continuously until completed. If paving operations are not begun within this time period, the Department will assess liquidated damages at the rate prescribed by Section 108.09 until such time as paving operations are begun.

Take possession of the millings and recycle the millings or dispose of the millings off the Right-of-Way at sites obtained by the Contractor at no additional cost to the Department.

1-3520 48 hours Contractor keeps millings
01/2/2012

SPECIAL NOTE FOR TYPICAL SECTION DIMENSIONS

Consider the dimensions shown on the typical sections for pavement and shoulder widths and thickness' to be nominal or typical dimensions. The Engineer may direct or approve varying the actual dimensions to be constructed to fit existing conditions. Do not widen existing pavement or shoulders unless specified elsewhere in this proposal or directed by the engineer.

1-3725 Typical Section Dimensions
01/02/2012

TRAFFIC CONTROL PLAN

TRAFFIC CONTROL GENERAL

Except as provided herein, maintain and control traffic in accordance with the Standard and Supplemental Specifications and the Standard and Sepia Drawings, current editions. Except for the roadway and traffic control bid items listed, all items of work necessary to maintain and control traffic will be paid at the lump sum bid price to "Maintain and Control Traffic".

Contrary to Section 106.01, furnish new, or used in like new condition, traffic control devices at the beginning of the work and maintain in like new condition until completion of the work.

ROAD CLOSURES

The Contractor may close sections of the road to through traffic during construction of the Full Depth Reclamation only. Road closure may not be before 8:00 am on week days, no restrictions for weekend hours. Local traffic within the closure and a school bus or emergency personnel on an official run arrives on the scene, make provisions for passage as quickly as possible. Do not leave road closures in place during non-working hours.

LANE CLOSURES

The Engineer may specify days and hours when lane closures will not be allowed.

Maintain alternating one way traffic during construction for asphalt paving operations. Provide a minimum clear lane width of 8 feet. If traffic should be stopped due to construction operations, and a school bus or emergency personnel on an official run arrives on the scene, make provisions for passage as quickly as possible. Do not leave lane closures in place during non-working hours.

SIGNS

Sign posts and splices shall be compliant with NCHRP 350 or MASH. Manufacturer's documentation validating this compliance shall be provided to the Engineer prior to installation. Signs, including any splices, shall be installed according to manufacturer's specifications and installation recommendations. Contrary to section 112.04.02, only long-term signs (signs intended to be continuously in place for more than 3 days) will be measured for payment. Short-term signs (signs intended to be left in place for 3 days or less) will not be measured for payment but will be incidental to Maintain and Control Traffic.

Traffic Control Plan
Page 2 of 9

CHANGEABLE MESSAGE SIGNS

Provide changeable message signs in advance of and within the project at locations determined by the Engineer. If work is in progress concurrently in both directions or if more than one lane closure is in place in the same direction of travel, provide additional changeable message signs as directed by the Engineer. Place changeable message signs one mile in advance of the anticipated queue at each lane closure. As the actual queue lengthens and/or shortens, relocate or provide additional changeable message signs so that traffic has warning of slowed or stopped traffic at least one mile but not more than two miles before reaching the end of the actual queue. The Engineer may vary the designated locations as the work progresses. The Engineer will determine the messages to be displayed. In the event of damage or mechanical/electrical failure, repair or replace the Changeable Message Sign within 24 hours. The Department will measure for payment the maximum number of Changeable Message Signs in concurrent use at the same time on a single day on all sections of the contract. The Department will measure individual Changeable Message Signs only once for payment, regardless of how many times they are set, reset, removed, and relocated during the duration of the project. The Department will not measure replacements for damaged Changeable Message Signs or for signs the Engineer directs be replaced due to poor condition or readability. Retain possession of the Changeable Message Signs upon completion of the work.

BARRICADES

The Department will not measure barricades used in lieu of barrels and cones for channelization or delineation, but shall be incidental to Maintain and Control Traffic according to Section 112.04.01.

The Department will measure barricades used for road closures and to protect pavement removal areas in individual units Each. The Department will measure for payment the maximum number of barricades in concurrent use at the same time on a single day on all sections of the contract. The Department will measure individual barricades only once for payment, regardless of how many times they are set, reset, removed, and relocated during the duration of the project. The Department will not measure replacements for damaged barricades the Engineer directs to be replaced due to poor condition or reflectivity. Retain possession of the Barricades upon completion of construction.

PAVEMENT MARKINGS

If there is to be a deviation from the existing striping plan, the Engineer will furnish the Contractor a striping plan prior to placement of the final surface course.

Install Temporary Striping according to Section 112 with the following exception:

If the Contractor's operations or phasing requires temporary markings that must subsequently be removed from the final surface course, use an approved removable lane tape; however, the Department will not measure removable lane tape for separate payment, but will measure and pay for removable lane tape as temporary striping.

Traffic Control Plan
Page 3 of 9

USE AND PLACEMENT OF CHANGEABLE MESSAGE SIGNS

The following policy is based upon current Changeable Message Signs (CMS) standards and practice from many sources, including the Federal Highway Administration (FHWA), other State Departments of Transportation, and Traffic Safety Associations. It is understood that each CMS installation or use requires individual consideration due to the specific location or purpose. However, there will be elements that are constant in nearly all applications. Accordingly these recommended guidelines bring a level of uniformity, while still being open to regional experience and engineering judgment.

Application

The primary purpose of CMS is to advise the driver of unexpected traffic and routing situations. Examples of applications where CMS can be effective include:

- Closures (road, lane, bridge, ramp, shoulder, interstate)
- Changes in alignment or surface conditions
- Significant delays, congestion
- Construction/maintenance activities (delays, future activities)
- Detours/alternative routes
- Special events with traffic and safety implications
- Crash/incidents
- Vehicle restrictions (width, height, weight, flammable)
- Advance notice of new traffic control devices
- Real-time traffic conditions (must be kept up to date)
- Weather /driving conditions, environmental conditions, Roadway Weather Information Systems
- Emergency Situations
- Referral to Highway Advisory Radio (if available)
- Messages as approved by the County Engineer's Office

CMS should not be used for:

- Replacement of static signs (e.g. road work ahead), regulatory signage (e.g. speed limits), pavement markings, standard traffic control devices, conventional warning or guide signs.
- Replacement of lighted arrow board
- Advertising (Don't advertise the event unless clarifying "action" to be taken by driver – e.g. Speedway traffic next exit)
- Generic messages
- Test messages (portable signs only)
- Describe recurrent congestion (e.g. rush hour)
- Public service announcements (not traffic related)

Traffic Control Plan
Page 4 of 9

Messages

Basic principles that are important to providing proper messages and insuring the proper operation of a CMS are:

- Visible for at least ½ mile under ideal daytime and nighttime conditions
- Legible from all lanes a minimum of 650 feet
- Entire message readable twice while traveling at the posted speed
- Nor more than two message panels should be used (three panels may be used on roadways where vehicles are traveling less than 45 mph). A panel is the message that fits on the face of the sign without flipping or scrolling.
- Each panel should convey a single thought; short and concise
- Do not use two unrelated panels on a sign
- Do not use the sign for two unrelated messages
- Should not scroll text horizontally or vertically
- Should not contain both the words left and right
- Use standardized abbreviations and messages
- Should be accurate and timely
- Avoid filler/unnecessary words and periods (hazardous, a, an, the)
- Avoid use of speed limits
- Use words (not numbers) for dates

Placement

Placement of the CMS is important to insure that the signs is visible to the driver and provides ample time to take any necessary action. Some of the following principles may only be applicable to controlled access roadways. The basic principles of placement for a CMS are:

- When 2 signs are needed, place on same side of roadway and at least 1,000 feet apart
- Place behind semi-rigid/rigid protection (guardrail, barrier) or outside of the clear zone
- Place 1,000 feet in advance of work zone; at least one mile ahead of decision point
- Normally place on right side of roadway; but should be placed closest to the affected lane so that either side is acceptable
- Signs should not be dual mounted (one on each side of roadway facing same direction)
- Point trailer hitch downstream
- Secure to immovable object to prevent thief (if necessary)
- Do not place in sags or just beyond crest
- Check for reflection of sun to prevent the blinding of motorist
- Should be turned ~3 degrees outward from perpendicular to the edge of pavement
- Bottom of sign should be 7 feet above the elevation of edge of roadway
- Should be removed when not in use
-

Traffic Control Plan
 Page 5 of 9

Standard Abbreviations

The following is a list of standard abbreviations to be used on CMS.

<u>Word</u>	<u>Abbrev.</u>	<u>Example</u>
Access	ACCS	ACCIDENT AHEAD/USE ACCS RD NEXT RIGHT
Alternate	ALT	ACCIDENT AHEAD/USE ALT RTE NEXT RIGHT
Avenue	AVE	FIFTH AVE CLOSED/DETOUR NEXT LEFT
Blocked	BLKD	FIFTH AVE BLKD/MERGE LEFT
Boulevard	BLVD	MAIN BLVD CLOSED/USE ALT RTE
Bridge	BRDG	SMITH BRDG CLOSED/USE ALT RTE
Cardinal Directions	N, S, E, W	N I75 CLOSED/ DETOUR EXIT 30
Center	CNTR	CNTR LANE CLOSED/MERGE LEFT
Commercial	COMM	OVRSZ COMM VEH/USE I275
Condition	COND	ICY COND POSSIBLE
Congested	CONG	HVY CONG NEXT 3 MI
Construction	CONST	CONST WORK AHEAD/EXPECT DELAYS
Downtown	DWNTN	DWNTN TRAF USE EX 40
Eastbound	E-BND	E-BND I64 CLOSED/DETOUR EXIT 20
Emergency	EMER	EMER VEH AHEAD/PREPARE TO STOP
Entrance, Enter	EX, EXT	DWNTN TRAF USE EX 40
Expressway	EXPWY	WTRSN EXPWY CLOSED/DETOUR EXIT 10
Freeway	FRWY, FWY	GN SYNDR FWY CLOSED/DETOUR EXIT 15
Hazardous Materials	HAZMAT	HAZMAT IN ROADWAY/ALL TRAF EXIT 25
Highway	HWY	ACCIDENT ON AA HWY/EXPECT DELAYS
Hour	HR	ACCIDENT ON AA HWY/2 HR DELAY
Information	INFO	TRAF INFO TUNE TO 1240 AM
Interstate	I	E-BND I64 CLOSED/DETOUR EXIT 20
Lane	LN	LN CLOSED/MERGE LEFT
Left	LFT	LANE CLOSED/MERGE LFT
Local	LOC	LOC TRAF USE ALT RTE
Maintenance	MAINT	MAINT WRK ON BRDG/SLOW
Major	MAJ	MAJ DELWAYS I75/USE ALT RTE

Traffic Control Plan
 Page 6 of 9

Mile	MI	ACCIDENT 3 MI AHEAD/ USE ALT RTE
Minor	MNR	ACCIDENT 3 MI MNR DELAY
Minutes	MIN	ACCIDENT 3 MI/30 MIN DELAY
Northbound	N-BND	N-BND I75 CLOSED/ DETOUR EXIT 50
Oversized	OVRSZ	OVRSZ COMM VEH/USE I275 NEXT RIGHT
Parking	PKING	EVENT PKING NEXT RGT
Parkway	PKWY	CUM PKWAY TRAF/DETOUR EXIT 60
Prepare	PREP	ACCIDENT 3 MIL/PREP TO STOP
Right	RGT	EVENT PKING NEXT RGT
Road	RD	HAZMAT IN RD/ALL TRAF EXIT 25
Roadwork	RDWK	RDWK NEXT 4 MI/POSSIBLE DELAYS
Route	RTE	MAJ DELAYS I75/USE ALT RTE
Shoulder	SHLDR	SHLDR CLOSED NEXT 5 MI
Slippery	SLIP	SLIP COND POSSIBLE/ SLOW SPD
Southbound	S-BND	S-BND I75 CLOSED/DETOUR EXIT 50
Speed	SPD	SLIP COND POSSIBLE/ SLOW SPD
Street	ST	MAIN ST CLOSED/USE ALT RTE
Traffic	TRAF	CUM PKWAY TRAF/DETOUR EXIT 60
Vehicle	VEH	OVRSZ COMM VEH/USE I275 NEXT RIGHT
Westbound	W-BND	W-BND I64 CLOSED/DETOUR EXIT 50
Work	WRK	CONST WRK 2MI/POSSIBLE DELAYS

Certain abbreviations are prone to inviting confusion because another word is abbreviated or could be abbreviated in the same way. DO NO USE THESE ABBREVIATIONS.

<u>Abbrev.</u>	<u>Intended Word</u>	<u>Word Erroneously Given</u>
ACC	Accident	Access (Road)
CLRS	Clears	Colors
DLY	Delay	Daily
FDR	Feeder	Federal
L	Left	Lane (merge)
LOC	Local	Location
LT	Light (traffic)	Left
PARK	Parking	Park
POLL	Pollution (index)	Poll
RED	Reduce	Red
STAD	Stadium	Standard

Traffic Control Plan
Page 7 of 9

TEMP
WRNG

Temporary
Warning

Temperature
Wrong

TYPICAL MESSAGES

The following is a list of typical messages used on CMS. The list consists of the reason or problem that you want the driver to be aware of and the action that you want the driver to take.

Reason/Problem

ACCIDENT
ACCIDENT/XX MILES
XX ROAD CLOSED
XX EXIT CLOSED
BRIDGE CLOSED
BRIDGE/(SLIPPERY, ICE, ETC.)
CENTER/LANE/CLOSED
DELAY(S), MAJOR/DELAYS
DEBRIS AHEAD
DENSE FOG
DISABLED/VEHICLE
EMER/VEHICLES/ONLY
EVENT PARKING
EXIT XX CLOSED
FLAGGER XX MILES
FOG XX MILES
FREEWAY CLOSED
FRESH OIL
HAZMAT SPILL
ICE
INCIDENT AHEAD
LANES (NARROW, SHIFT, MERGE, ETC.)
LEFT LANE CLOSED
LEFT LANE NARROWS
LEFT 2 LANES CLOSED
LEFT SHOULDER CLOSED
LOOSE GRAVEL
MEDIAN WORK XX MILES
MOVING WORK ZONE, WORKERS IN ROADWAY
NEXT EXIT CLOSED
NO OVERSIZED LOADS
NO PASSING
NO SHOULDER
ONE LANE BRIDGE

Action

ALL TRAFFIC EXIT RT
AVOID DELAY USE XX
CONSIDER ALT ROUTE
DETOUR
DETOUR XX MILES
DO NOT PASS
EXPECT DELAYS
FOLLOW ALT ROUTE
KEEP LEFT
KEEP RIGHT
MERGE XX MILES
MERGE LEFT
MERGE RIGHT
ONE-WAY TRAFFIC
PASS TO LEFT
PASS TO RIGHT
PREPARE TO STOP
REDUCE SPEED
SLOW
SLOW DOWN
STAY IN LANE
STOP AHEAD
STOP XX MILES
TUNE RADIO 1610 AM
USE NN ROAD
USE CENTER LANE
USE DETOUR ROUTE
USE LEFT TURN LANE
USE NEXT EXIT
USE RIGHT LANE
WATCH FOR FLAGGER

Traffic Control Plan
Page 8 of 9

PEOPLE CROSSING
RAMP CLOSED
RAMP (SLIPPERY, ICE, ETC.)
RIGHT LANE CLOSED
RIGHT LANE NARROWS
RIGHT SHOULDER CLOSED
ROAD CLOSED
ROAD CLOSED XX MILES
ROAD (SLIPPERY, ICE, ETC.)
ROAD WORK
ROAD WORK (OR CONSTRUCTION) (TONIGHT, TODAY, TOMORROW, DATE)
ROAD WORK XX MILES
SHOULDER (SLIPPERY, ICE, SOFT, BLOCKED, ETC.)
NEW SIGNAL XX MILES
SLOW 1 (OR 2) - WAY TRAFFIC
SOFT SHOULDER
STALLED VEHICLES AHEAD
TRAFFIC BACKUP
TRAFFIC SLOWS
TRUCK CROSSING
TRUCKS ENTERING
TOW TRUCK AHEAD
UNEVEN LANES
WATER ON ROAD
WET PAINT
WORK ZONE XX MILES
WORKERS AHEAD

PAVEMENT EDGE DROP-OFFS

Do not allow a pavement edge between opposing directions of traffic or lanes that traffic is expected to cross in a lane change situation with an elevation difference greater than 1½". Place Warning signs (MUTCD W8-11 or W8-9A) in advance of and at 1500' intervals throughout the drop-off area. Dual post the signs on both sides of the traveled way. Wedge all transverse transitions between resurfaced and unresurfaced areas which traffic may cross with asphalt mixture for leveling and wedging. Remove the wedges prior to placement of the final surface course.

Protect pavement edges that traffic is not expected to cross, except accidentally, as follows:

Less than 2" - No protection required.

2" to 4" - Place plastic drums, vertical panels, or barricades every 50 feet. During daylight working hours only, the Engineer will allow the Contractor to use cones in lieu of plastic drums, panels, and barricades. Wedge the drop-off with DGA or

Traffic Control Plan
Page 9 of 9

asphalt mixture for leveling and wedging with a 1:1 or flatter slope in daylight hours, or 3:1 or flatter slope during nighttime hours, when work is not active in the drop-off area.

Greater than 4" - Protect drop-offs greater than 4 inches within 10 feet of traffic by placing drums, vertical panels, or barricades every 25 feet. The Engineer will not allow the use of cones in lieu of drums, vertical panels, or barricades for drop-offs greater than 4". Place Type III Barricades directly in front of the drop-off facing on coming traffic in both directions of travel. Provide warning signs as shown on the Standard Drawings or as directed by the Engineer

Pedestrians & Bicycles - Protect pedestrian and bicycle traffic as directed by the engineer.

DURABLE PAVEMENT EDGE DETAIL

(Resurfacing adjacent to fill slope or ditch foreslope that is 3:1 or less)

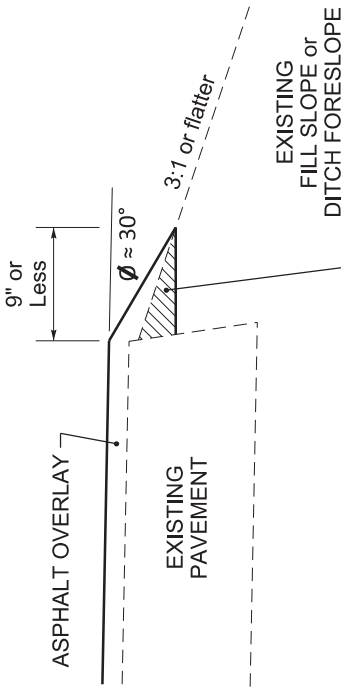

PREPARE SHOULDER ACCORDING TO STANDARD SPECIFICATIONS

DURABLE PAVEMENT EDGE DETAIL

(Resurfacing adjacent to fill slope or ditch foreslope that is steeper than 3:1)

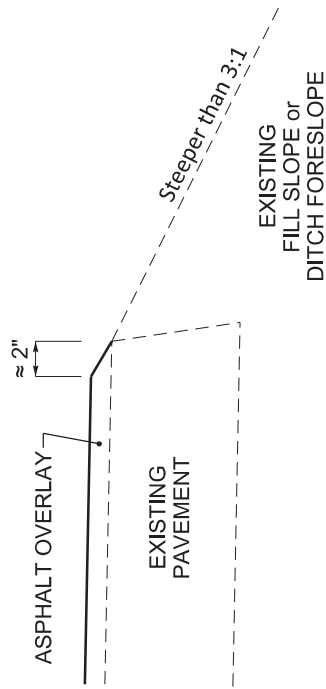

DURABLE PAVEMENT EDGE DETAIL

(Resurfacing adjacent to low shoulder with dropoff of 5 inches or less)

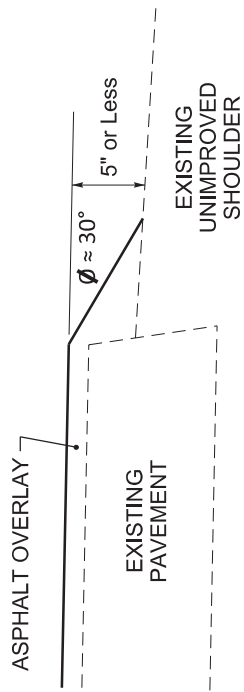

DURABLE PAVEMENT EDGE DETAIL

(Resurfacing adjacent to low shoulder with dropoff of more than 5 inches)

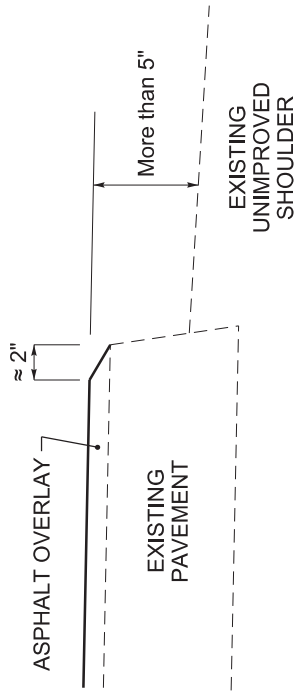

DURABLE PAVEMENT EDGE DETAIL

(Resurfacing adjacent to an obstruction, such as an existing headwall)

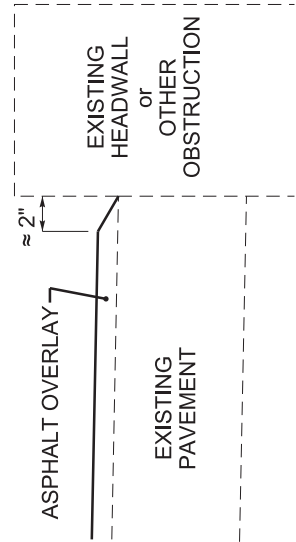

NOTES

1. DETAILS DO NOT APPLY TO OVERLAYS LESS THAN 1 INCH THICK.
2. THE DURABLE PAVEMENT EDGE DEVICE MAY BE DISENGAGED AT DRIVEWAYS, SIDE STREETS, HIGH SHOULDERS, AND OTHER LOCATIONS NOT FEASIBLE TO CONSTRUCT, AS APPROVED BY THE ENGINEER.

DRAWING NOT TO SCALE

DURABLE PAVEMENT EDGE DETAILS

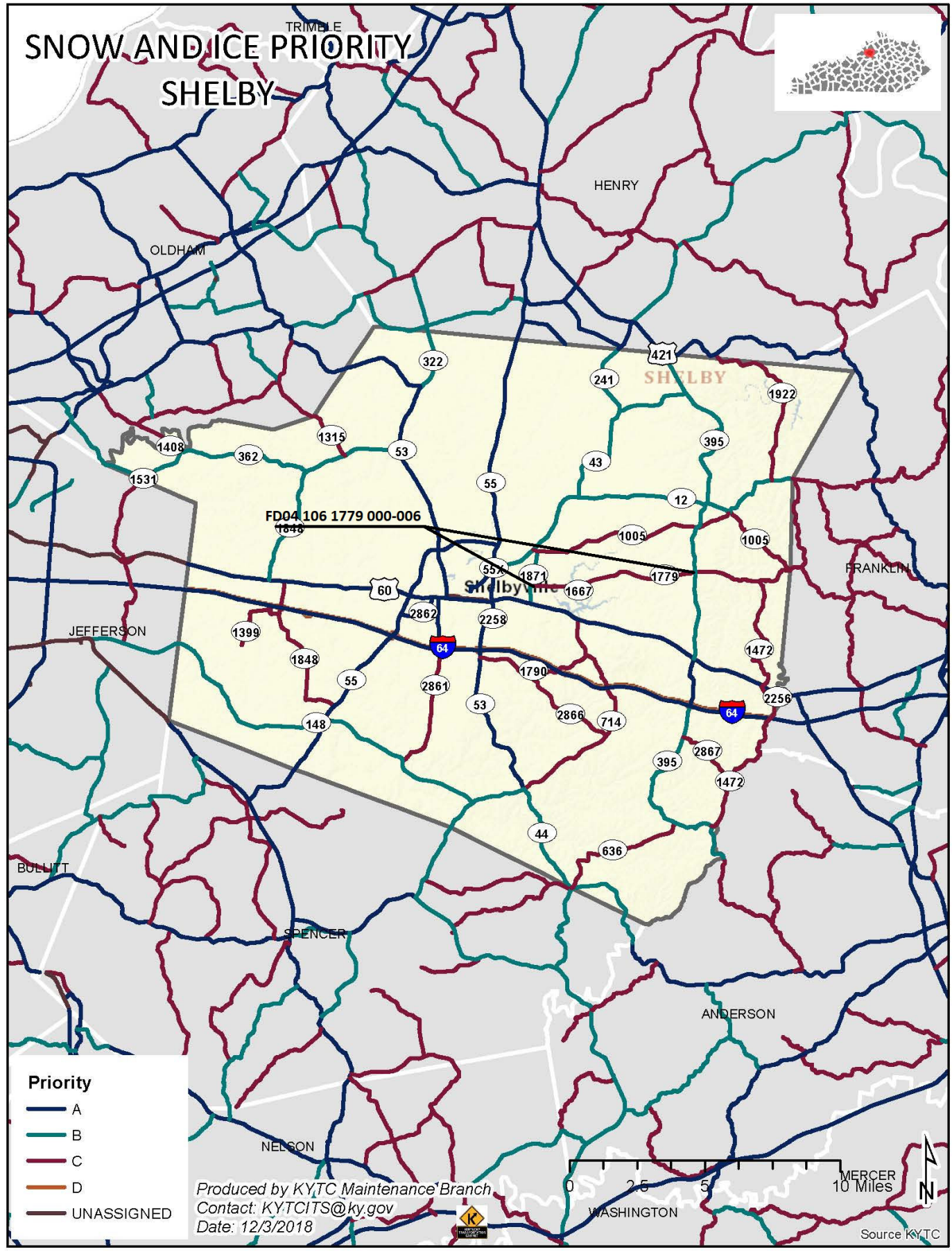

**Shelby County
TYPICAL SECTION
FD04 106 1779 000-006
MP's 0.000 to 6.133**

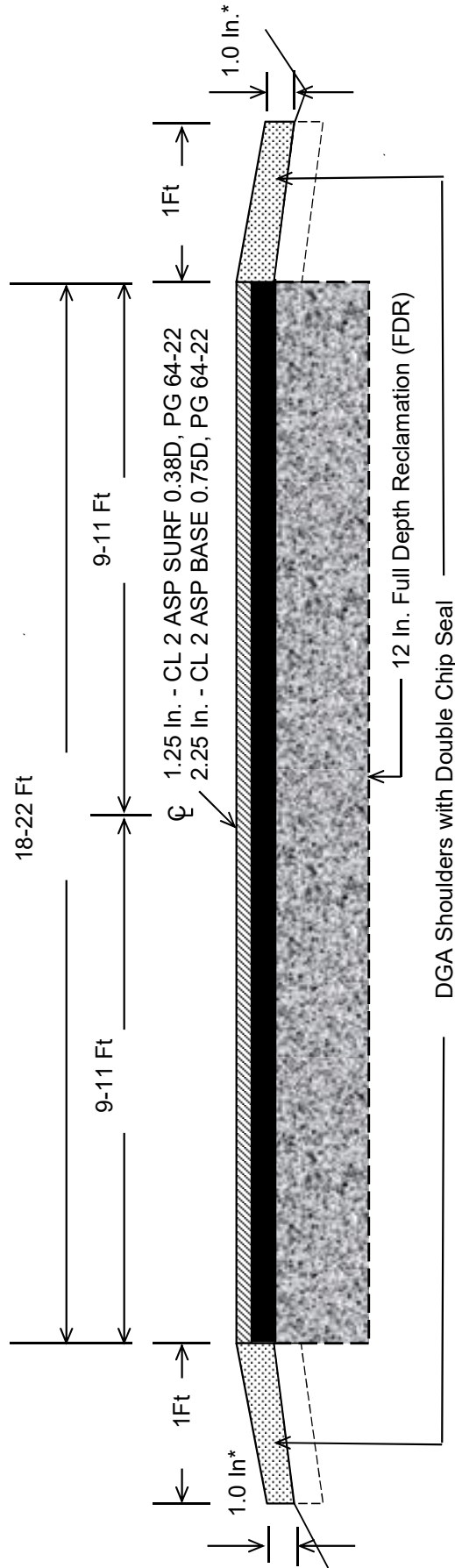

Apply Asphalt Material for Tack - Non Tracking as the curing seal for FDR.

Excess spoils from FDR may be graded to build up shoulders

Chip Seal Applications:

First Course: Asphalt Seal Coat - Rate of 3.2 LBS/SQ.SY, Asphalt Seal Agg - Rate of 30 LBS/SQ.SY

Second Course: Asphalt Seal Coat - Rate of 2.8 LBS/SQ.SY, Asphalt Seal Agg - Rate of 20 LBS/SQ.SY

***Where Existing Site Conditions Permit**

BRIDGE DETAIL FOR PAVING PROJECT

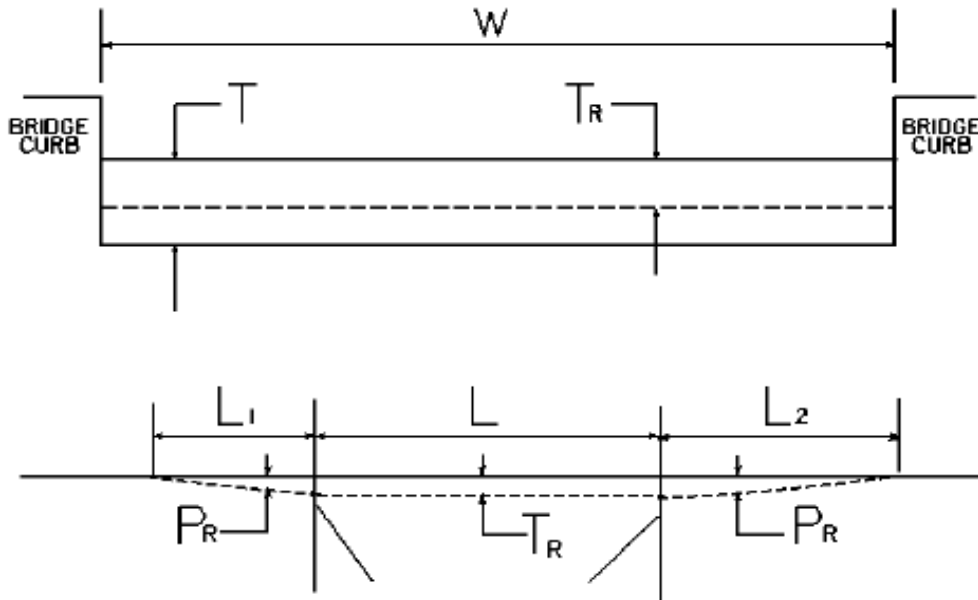

W = bridge width curb to curb
 T = thickness of existing asphalt overlay
 L = length of bridge
 L_1 & L_2 = length of approach pavement to be removed
 T_R = thickness to be removed and replaced on bridge
 P_R = thickness to be removed and replaced on pavement
 Note: L_1 & L_2 lengths shall be determined by using a transition rate of 100 ft/in of thickness

Route	Bridge No.	MP	W (ft)	T (in)	L ₁ (ft)	L ₂ (ft)	T _R (in)	L (ft)	P _R (in)
KY 1779	B00034N	1.323	22.00	6.00	350.00	350.00		158.4	3.500

PART II
SPECIFICATIONS AND STANDARD DRAWINGS

SPECIFICATIONS REFERENCE

Any reference in the plans or proposal to previous editions of the *Standard Specifications for Road and Bridge Construction* and *Standard Drawings* are superseded by *Standard Specifications for Road and Bridge Construction, Edition of 2019* and *Standard Drawings, Edition of 2016*.

SUPPLEMENTAL SPECIFICATIONS

The contractor shall use the Supplemental Specifications that are effective at the time of letting.
The Supplemental Specifications can be found at the following link:

<http://transportation.ky.gov/Construction/Pages/Kentucky-Standard-Specifications.aspx>

2016 KENTUCKY STANDARD DRAWINGS

CURVE WIDENING AND SUPERELEVATION TRANSITIONS.....	RGS-001-07
SUPERELEVATION FOR MULTILANE PAVEMENTS.....	RGS-002-06
MISCELLANEOUS STANDARDS PART 1.....	RGX-001-06
APPROACHES, ENTRANCES, AND MAIL BOX TURNOUT.....	RPM-110-07
LANE CLOSURE TWO-LANE HIGHWAY.....	TTC-100-04
LANE CLOSURE MULTI-LANE HIGHWAY CASE I.....	TTC-115-02
DOUBLE LANE CLOSURE.....	TTC-125-03
SHOULDER CLOSURE.....	TTC-135-02
PAVEMENT CONDITION WARNING SIGNS.....	TTD-125-02
MOBILE OPERATION FOR PAINT STRIPING CASE I.....	TTS-100-02
MOBILE OPERATION FOR PAINT STRIPING CASE II.....	TTS-105-02

PART III

EMPLOYMENT, WAGE AND RECORD REQUIREMENTS

**TRANSPORTATION CABINET
DEPARTMENT OF HIGHWAYS**

**LABOR AND WAGE REQUIREMENTS
APPLICABLE TO OTHER THAN FEDERAL-AID SYSTEM PROJECTS**

- I. Application
- II. Nondiscrimination of Employees (KRS 344)

I. APPLICATION

1. These contract provisions shall apply to all work performed on the contract by the contractor with his own organization and with the assistance of workmen under his immediate superintendence and to all work performed on the contract by piecework, station work or by subcontract. The contractor's organization shall be construed to include only workmen employed and paid directly by the contractor and equipment owned or rented by him, with or without operators.

2. The contractor shall insert in each of his subcontracts all of the stipulations contained in these Required Provisions and such other stipulations as may be required.

3. A breach of any of the stipulations contained in these Required Provisions may be grounds for termination of the contract.

3. If the contractor is in control of apprenticeship or other training or retraining, including on-the-job training programs, he shall not discriminate against an individual because of his race, color, religion, national origin, sex, disability or age forty (40) and over, in admission to, or employment in any program established to provide apprenticeship or other training.

4. The contractor will send to each labor union or representative of workers with which he has a collective bargaining agreement or other contract or understanding, a notice to be provided advising the said labor union or workers' representative of the contractor's commitments under this section, and shall post copies of the notice in conspicuous places available to employees and applicants for employment. The contractor will take such action with respect to any subcontract or purchase order as the administrating agency may direct as a means of enforcing such provisions, including sanctions for non-compliance.

Revised: January 25, 2017

II. NONDISCRIMINATION OF EMPLOYEES

**AN ACT OF THE KENTUCKY
GENERAL ASSEMBLY TO PREVENT
DISCRIMINATION IN EMPLOYMENT
KRS CHAPTER 344
EFFECTIVE JUNE 16, 1972**

The contract on this project, in accordance with KRS Chapter 344, provides that during the performance of this contract, the contractor agrees as follows:

1. The contractor shall not fail or refuse to hire, or shall not discharge any individual, or otherwise discriminate against an individual with respect to his compensation, terms, conditions, or privileges of employment, because of such individual's race, color, religion, national origin, sex, disability or age (forty and above); or limit, segregate, or classify his employees in any way which would deprive or tend to deprive an individual of employment opportunities or otherwise adversely affect his status as an employee, because of such individual's race, color, religion, national origin, sex, disability or age forty (40) and over. The contractor agrees to post in conspicuous places, available to employees and applicants for employment, notices to be provided setting forth the provisions of this nondiscrimination clause.

2. The contractor shall not print or publish or cause to be printed or published a notice or advertisement relating to employment by such an employer or membership in or any classification or referral for employment by the employment agency, indicating any preference, limitation, specification, or discrimination, based on race, color, religion, national origin, sex, or age forty (40) and over, or because the person is a qualified individual with a disability, except that such a notice or advertisement may indicate a preference, limitation, or specification based on religion, national origin, sex, or age forty (40) and over, or because the person is a qualified individual with a disability, when religion, national origin, sex, or age forty (40) and over, or because the person is a qualified individual with a disability, is a bona fide occupational qualification for employment.

EXECUTIVE BRANCH CODE OF ETHICS

In the 1992 regular legislative session, the General Assembly passed and Governor Brereton Jones signed Senate Bill 63 (codified as KRS 11A), the Executive Branch Code of Ethics, which states, in part:

KRS 11A.040 (7) provides:

No present or former public servant shall, within six (6) months following termination of his office or employment, accept employment, compensation, or other economic benefit from any person or business that contracts or does business with, or is regulated by, the state in matters in which he was directly involved during the last thirty-six (36) months of his tenure. This provision shall not prohibit an individual from returning to the same business, firm, occupation, or profession in which he was involved prior to taking office or beginning his term of employment, or for which he received, prior to his state employment, a professional degree or license, provided that, for a period of six (6) months, he personally refrains from working on any matter in which he was directly involved during the last thirty-six (36) months of his tenure in state government. This subsection shall not prohibit the performance of ministerial functions, including but not limited to filing tax returns, filing applications for permits or licenses, or filing incorporation papers, nor shall it prohibit the former officer or public servant from receiving public funds disbursed through entitlement programs.

KRS 11A.040 (9) states:

A former public servant shall not represent a person or business before a state agency in a matter in which the former public servant was directly involved during the last thirty-six (36) months of his tenure, for a period of one (1) year after the latter of:

- a) The date of leaving office or termination of employment; or
- b) The date the term of office expires to which the public servant was elected.

This law is intended to promote public confidence in the integrity of state government and to declare as public policy the idea that state employees should view their work as a public trust and not as a way to obtain private benefits.

If you have worked for the executive branch of state government within the past six months, you may be subject to the law's prohibitions. The law's applicability may be different if you hold elected office or are contemplating representation of another before a state agency.

Also, if you are affiliated with a firm which does business with the state and which employs former state executive-branch employees, you should be aware that the law may apply to them.

In case of doubt, the law permits you to request an advisory opinion from the Executive Branch Ethics Commission, 3 Fountain Place, Frankfort, Kentucky 40601; telephone (502) 564-7954.

Revised: January 27, 2017

Kentucky Equal Employment Opportunity Act of 1978

The requirements of the Kentucky Equal Employment Opportunity Act of 1978 (KRS 45.560-45.640) shall apply to this Contract. The apparent low Bidder will be required to submit EEO forms to the Division of Construction Procurement, which will then forward to the Finance and Administration Cabinet for review and approval. No award will become effective until all forms are submitted and EEO/CC has certified compliance. The required EEO forms are as follows:

- EEO-1: Employer Information Report
- Affidavit of Intent to Comply
- Employee Data Sheet
- Subcontractor Report

These forms are available on the Finance and Administration's web page under ***Vendor Information, Standard Attachments and General Terms*** at the following address:
<https://www.eProcurement.ky.gov>.

Bidders currently certified as being in compliance by the Finance and Administration Cabinet may submit a copy of their approval letter in lieu of the referenced EEO forms.

For questions or assistance please contact the Finance and Administration Cabinet by email at **finance.contractcompliance@ky.gov** or by phone at 502-564-2874.

EMPLOYEE RIGHTS UNDER THE FAIR LABOR STANDARDS ACT

THE UNITED STATES DEPARTMENT OF LABOR WAGE AND HOUR DIVISION

FEDERAL MINIMUM WAGE

\$7.25

 PER HOUR

BEGINNING JULY 24, 2009

OVERTIME PAY At least 1½ times your regular rate of pay for all hours worked over 40 in a workweek.

CHILD LABOR An employee must be at least **16** years old to work in most non-farm jobs and at least **18** to work in non-farm jobs declared hazardous by the Secretary of Labor.

Youths **14** and **15** years old may work outside school hours in various non-manufacturing, non-mining, non-hazardous jobs under the following conditions:

No more than

- **3** hours on a school day or **18** hours in a school week;
- **8** hours on a non-school day or **40** hours in a non-school week.

Also, work may not begin before **7 a.m.** or end after **7 p.m.**, except from June 1 through Labor Day, when evening hours are extended to **9 p.m.** Different rules apply in agricultural employment.

TIP CREDIT Employers of “tipped employees” must pay a cash wage of at least \$2.13 per hour if they claim a tip credit against their minimum wage obligation. If an employee’s tips combined with the employer’s cash wage of at least \$2.13 per hour do not equal the minimum hourly wage, the employer must make up the difference. Certain other conditions must also be met.

ENFORCEMENT The Department of Labor may recover back wages either administratively or through court action, for the employees that have been underpaid in violation of the law. Violations may result in civil or criminal action.

Employers may be assessed civil money penalties of up to \$1,100 for each willful or repeated violation of the minimum wage or overtime pay provisions of the law and up to \$11,000 for each employee who is the subject of a violation of the Act’s child labor provisions. In addition, a civil money penalty of up to \$50,000 may be assessed for each child labor violation that causes the death or serious injury of any minor employee, and such assessments may be doubled, up to \$100,000, when the violations are determined to be willful or repeated. The law also prohibits discriminating against or discharging workers who file a complaint or participate in any proceeding under the Act.

ADDITIONAL INFORMATION

- Certain occupations and establishments are exempt from the minimum wage and/or overtime pay provisions.
- Special provisions apply to workers in American Samoa and the Commonwealth of the Northern Mariana Islands.
- Some state laws provide greater employee protections; employers must comply with both.
- The law requires employers to display this poster where employees can readily see it.
- Employees under 20 years of age may be paid \$4.25 per hour during their first 90 consecutive calendar days of employment with an employer.
- Certain full-time students, student learners, apprentices, and workers with disabilities may be paid less than the minimum wage under special certificates issued by the Department of Labor.

For additional information:



1-866-4-USWAGE

(1-866-487-9243) TTY: 1-877-889-5627



WWW.WAGEHOUR.DOL.GOV

PART IV
INSURANCE

Refer to
Kentucky Standard Specifications for Road and Bridge Construction,
current edition

PART V
BID ITEMS

PROPOSAL BID ITEMS

Report Date 10/21/19

Section: 0001 - PAVING

LINE	BID CODE	ALT	DESCRIPTION	QUANTITY	UNIT	UNIT PRIC	FP	AMOUNT
0010	00001		DGA BASE	1,800.00	TON		\$	
0020	00100		ASPHALT SEAL AGGREGATE	180.00	TON		\$	
0030	00103		ASPHALT SEAL COAT	22.00	TON		\$	
0040	00221		CL2 ASPH BASE 0.75D PG64-22	9,150.00	TON		\$	
0050	00301		CL2 ASPH SURF 0.38D PG64-22	5,350.00	TON		\$	
0060	02542		CEMENT	2,200.00	TON		\$	
0070	02562		TEMPORARY SIGNS	400.00	SQFT		\$	
0080	02650		MAINTAIN & CONTROL TRAFFIC	1.00	LS		\$	
0090	02671		PORTABLE CHANGEABLE MESSAGE SIGN	2.00	EACH		\$	
0100	02676		MOBILIZATION FOR MILL & TEXT	1.00	LS		\$	
0110	02677		ASPHALT PAVE MILLING & TEXTURING	240.00	TON		\$	
0120	06510		PAVE STRIPING-TEMP PAINT-4 IN	130,000.00	LF		\$	
0130	06514		PAVE STRIPING-PERM PAINT-4 IN	130,000.00	LF		\$	
0140	10020NS		FUEL ADJUSTMENT	23,146.00	DOLL	\$1.00	\$	\$23,146.00
0150	10030NS		ASPHALT ADJUSTMENT	56,689.00	DOLL	\$1.00	\$	\$56,689.00
0160	24936EC		FULL DEPTH RECLAMATION WITH CEMENT	73,812.00	SQYD		\$	
0170	24970EC		ASPHALT MATERIAL FOR TACK NON-TRACKING (REVISED: 10-21-19)	103.00	TON		\$	

Section: 0002 - DEMOBILIZATION

LINE	BID CODE	ALT	DESCRIPTION	QUANTITY	UNIT	UNIT PRIC	FP	AMOUNT
0180	02569		DEMOBILIZATION	1.00	LS		\$	